

## FEATURES

- Extremely Low supply current ( $<1\mu\text{A}$ ).
- $>45\text{dB}$  mute attenuation.
- Shunt operation.
- SOFTMUTE during normal operation.
- Built-in expansion capability, SOFTMUTE out for driving additional channels.
- Instantaneous. Power-up and Power-down muting.
- ESD protected outputs.
- 1.5V to 2.7V supply operation.
- Compact 2 x 2 x 0.6mm 8 lead DFN.

## APPLICATIONS

- Cell phones
- PDA's
- Portable DVD players
- Portable MP3 players
- Notebook Audio
- Set-top boxes
- Digital Video Recorders
- LCD TVs
- Home Theater systems

## Pin Layout

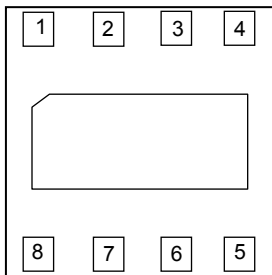

## GENERAL DESCRIPTION

PA4201 (*PUNK*) is a low power ( $I_{CC} < 1\mu\text{A}$ ) monolithic CMOS mixed signal device.

PUNK's primary function is to control power supply transition noise in audio circuits and systems.

PUNK boasts several features that make it a "one of a kind" product on the market. Most prominent is the feature that allows the designer to implement SOFTMUTE on an audio line during normal operation. PUNK is an exceptional product for multi-channel devices as it is capable of expanding the SOFTMUTE operation into systems such as Dolby<sup>®</sup>5.1, DTS<sup>™</sup>.

PUNK requires few external components for its operation, working from low to medium supply voltages of 1.5V to 2.7V.

On power-up and power-down the audio inputs to succeeding amplifiers are switched to a convenient low impedance voltage rail. Muting the amplifiers, preventing the audible pop, that is normally heard in the headset.

PUNK operates as a passive shunt device. So the designer does not have to worry about the PUNK introducing any kind of noise or distortion into the system. While consuming less than  $1\mu\text{A}$  of supply current PUNK provides more than 45dB of mute attenuation at the audio lines.

PUNK is equipped with ESD (Human Body Model) protection circuitry on the outputs.

PUNK is available as an 8L low profile 0.6mm DFN package and is specified for operation over the  $-40^{\circ}\text{C}$  to  $+85^{\circ}\text{C}$  temperature range.

## Typical Application Circuit

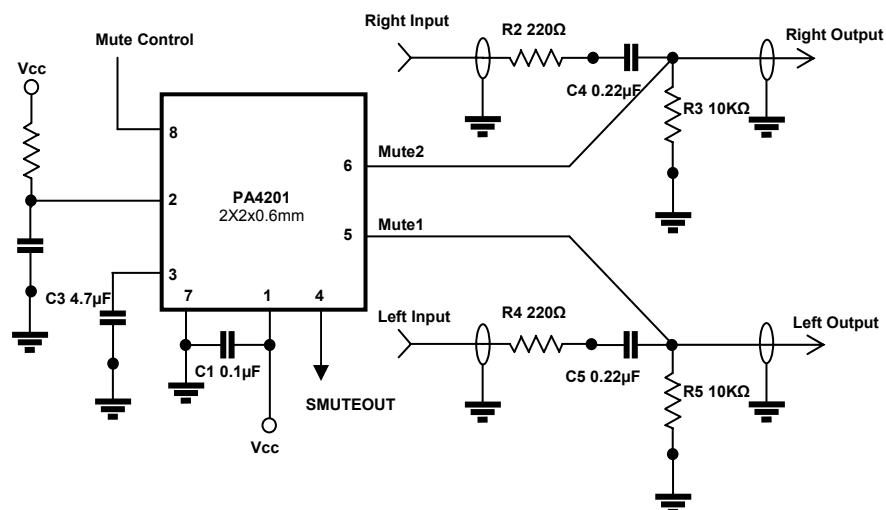

**PIN OUT**

Pin	Name	Function
1	VCC	Positive power supply. 1.5V to 2.7V $\pm$ 10%
2	RCS	Power On mute delay resistor-capacitor connection
3	CEXT	Soft mute delay capacitor
4	SMUTEOUT	Soft Mute OUT for multiple channels
5	MUTE1	Open Drain output of NFET 1
6	MUTE2	Open Drain output of NFET 2
7	GND	Ground
8	MUTECONT	Mute control signal from microprocessor

**ABSOLUTE MAXIMUM RATINGS**

Sustained operation at or above the following ratings is not recommended. Catastrophic and irreversible damage will occur to the device at or above these ratings.

Symbol	Description	Rating
VX	Voltage at any pin	-0.3 to 7.0+ 0.3 V
IX	Current at any pin	500mA
TA	Ambient Temperature	150 °C
TS	Storage Temperature	200 °C
TSOL	Soldering Temperature	260 °C

**RECOMMENDED OPERATING CONDITIONS:**

**DC OPERATING CONDITIONS**

Unless otherwise specified,  $V_{DD}=3 \pm 10\%$ ,  $T_A = \text{Ambient Temperature} = 25 \text{ }^\circ\text{C}$ .

Symbol	Parameter	Condition	Limit			Unit
			Min	Typical	Max	
$V_{DD}$	Power Supply	Normal Operation	1.5		3.0	V
$I_{DD}$	Supply Current	Normal Operation			1	$\mu\text{A}$
$T_A$	Ambient Temperature	Normal Operation	-40		85	$^\circ\text{C}$
$V_{OH}$	Logic High O/P Voltage	$I_{OH}=100\mu\text{A}$	$V_{DD}-0.1$			V
$V_{OL}$	Logic Low O/P Voltage	$I_{OL}=-100\mu\text{A}$			0.2	V
$V_{IH}$	Logic High I/P Voltage	$I_{IH}=1\mu\text{A}$	$V_{DD}-0.3$			V
$V_{IL}$	Logic Low I/P Voltage	$I_{IL}=1\mu\text{A}$			0.3	V
$R_{ON}$	FET ON Resistance	$V_{DD} = 2.7\text{V}, V_{DFET} = 0.4\text{V}$		0.88	1.1	$\Omega$
		$V_{CC} = 5.5\text{V}, V_{DFET} = 0.4\text{V}$		0.55	0.66	
$R_{FLAT(ON)}$	ON Resistance Flatness	Over Input Voltage Range		3.55		$\text{m}\Omega$
THD	Total Harmonic Distortion	$R_L = 32 \Omega, 30\text{mW}, f = 1\text{kHz}$		.020		%
$X_{TALK}$	Crosstalk (on)	$F = 20\text{kHz}$		-100		dB
$V_{SIG}$	Analog Signal Range	Normal Operation			0.7	$V_{RMS}$

**MUTE OPERATING CONDITIONS**

Symbol	Parameter	Condition	Limit			Unit
			Min	Typical	Max	
$M_{OFFD}$	Mute release delay	Mute Control =VIL Set by ext. RC network at RCS pin	10			mS
$M_{STD}$	Soft mute fall/rise time	Mute Control transitions to VIH. Set by ext. capacitor CEXT	1			mS
$M_{PDEL}^*$	Mute ON Delay	Mute control signal, Low to High transition			1	$\mu\text{S}$
$N_{FETV}^*$	NFET open drain volt				7.0	V

\* Guaranteed by design

**TURN ON TIME**

$C_{ext}$ $\mu$ F	$t_{softmute}$ in ms
0.1	36.03
0.2	71.06
0.3	97.4
0.4	110.05
0.5	117.2

**CAPACITIVE LOAD**

Max Cap Load @ SMUTEOUT		
$V_{DD}$	T mS	$C_{EXT}$ nF
5.5	18	20
3.3	20	15
2.7	20	15

**THEORY OF OPERATION**

**STARTUP**

During Startup, the Power supply ramps from 0V to VCC. This time is usually in excess of 20ms. As soon as this change in voltage is sensed, PUNK latches the Mute Controller outputs to HIGH, thus “muting” the lines. This is the Startup Operation (figure 1). The duration for which the controller outputs are latched HIGH can be controlled by an external RC circuit. When the voltage at this RC pin reaches a certain threshold, the mute controller releases the lines (Gate voltage is LOW) and Normal Operation starts.

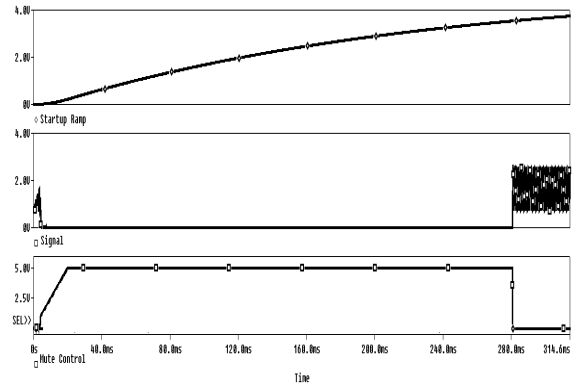

Figure 1: Startup Pop-Noise Reduction

**SHUTDOWN**

During Shutdown, the reverse process happens. As the power supply reaches the threshold on its way down, the mute controller again latches the outputs to HIGH, thus “muting” the lines (figure 2). This muting prevents unwanted signal spikes from getting to the power amplifiers. However, for optimal performance, it is suggested to mute the lines using the MUTECONT signal before power down. This process will ensure that the pop noise involved during shutdown is diminished

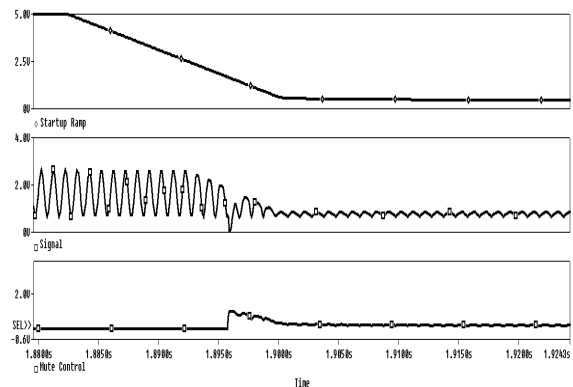

Figure 2: Shutdown Pop-Noise Reduction

**SOFTMUTE**

During normal operation, PUNK is in OFF state. But if there arises a situation when the audio lines need to be muted, the designer can do this by asserting the MUTECONT signal to HIGH. This will initiate a SOFTMUTE sequence (figure 3). When the MUTECONT signal is asserted, the mute controller gradually ramps the control voltages in a “SOFT” fashion so as to provide a soft mute operation. The mute delay is fully controllable by the designer by using an external capacitor at CEXT. Typical values of CEXT are between 0.1µF and 0.5µF. The reverse happens when the MUTECONT signal is released. This operation is explained in detail in the Application Circuit section.

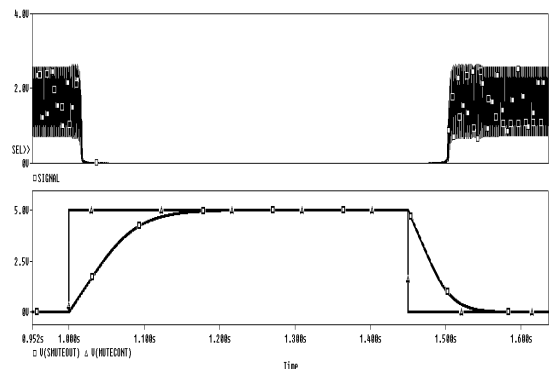

Figure 3: SOFT mute operation

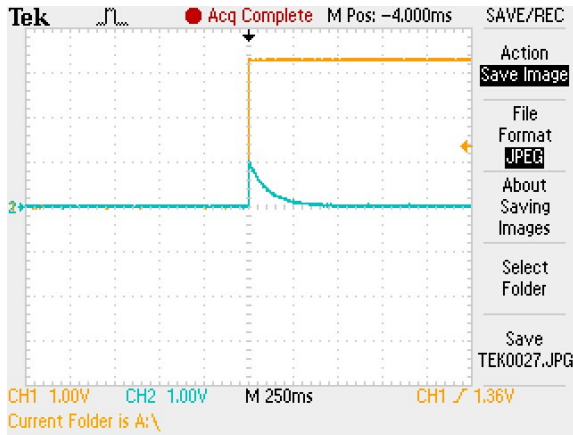

Figure 4: Startup Pop-Noise without PUNK

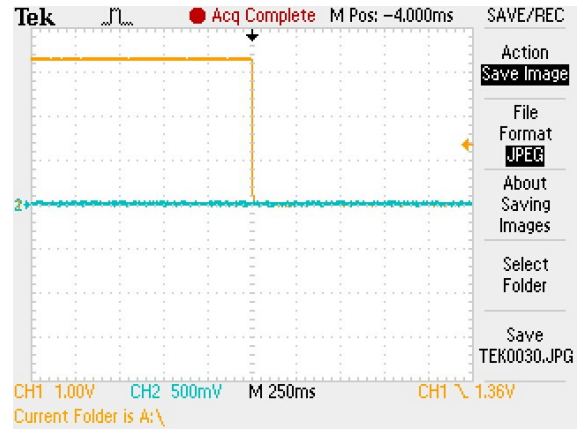

Figure 7: Shutdown Pop-Noise with PUNK



Figure 5: Shutdown Pop-Noise without PUNK

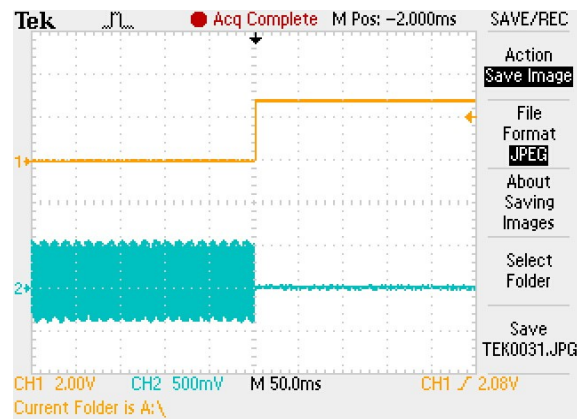

Figure 8: Audio Mute Enable



Figure 6: Startup Pop-Noise with PUNK

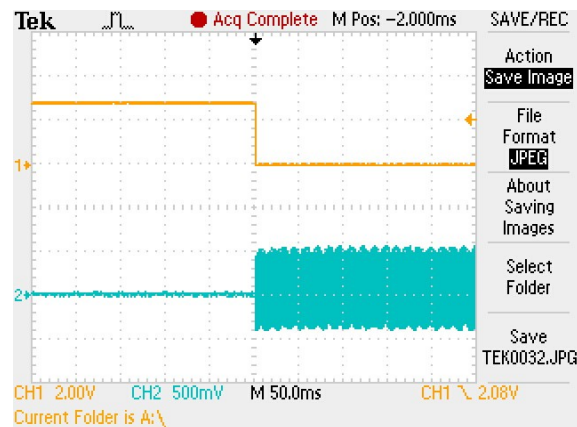
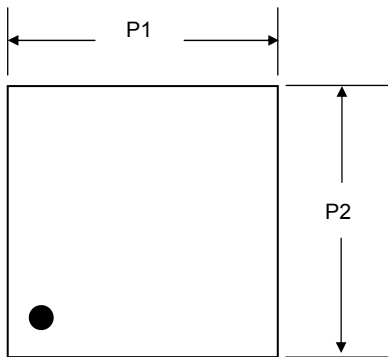
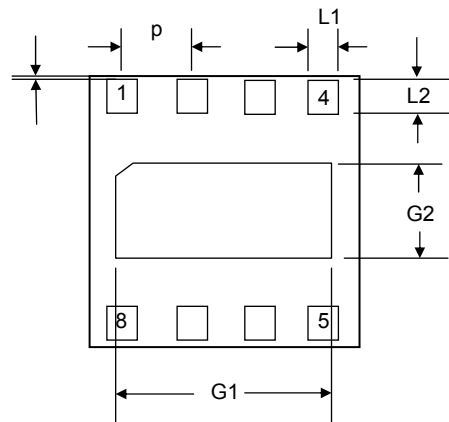

Figure 9: Audio Mute Disable

PACKAGE DIMENSIONS AND MEASUREMENTS PA4201DN



TOP VIEW



BOTTOM VIEW

Dim	MILLIMETERS		
	MIN	TYP	MIN
P1	1.95	2.00	2.05
P2	1.95	2.00	2.05
P3	0.50	0.60	0.70
L1	0.23	0.25	0.27
L2	0.33	0.35	0.40
L3	0.02	0.02	0.02
p	0.50	0.50	0.50
G1	1.50	1.60	1.70
G2	0.60	0.70	0.80
g			

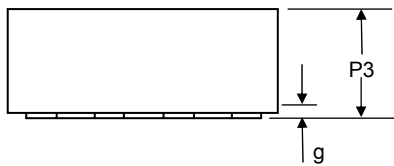

SIDE VIEW

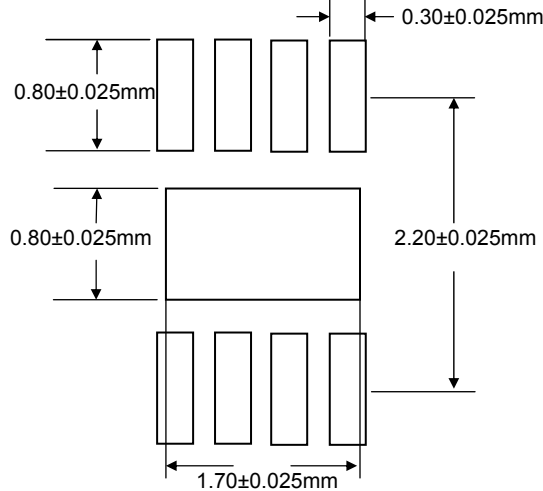

Recommended Pattern Layout

Reel Dia	A0	B0	K0	D	E	F	W	P0	P2	P	t-max
178 (7")	2.00±0.10	2.00±0.10	0.65±0.10	1.50±0.10	1.75±0.10	3.50±0.05	8.00±0.30	4.00±0.10	2.00±0.05	4.00±0.10	0.25

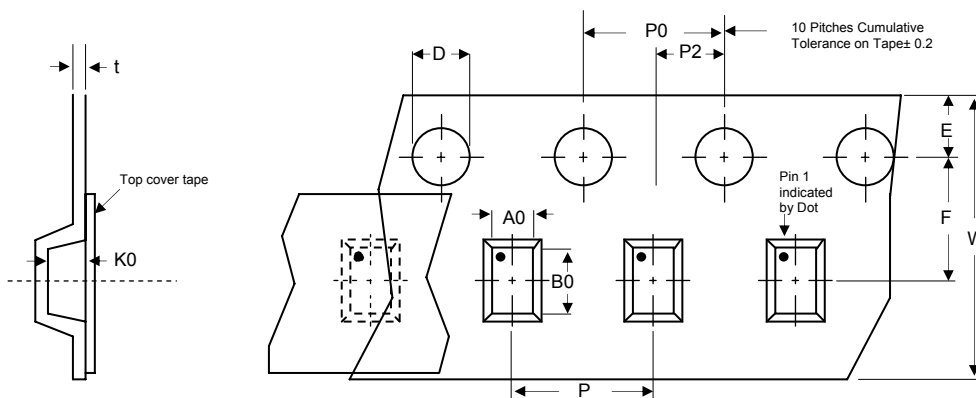

PACKAGE DIMENSIONS AND MEASUREMENTS PA4201DQ

### PACKAGE OUTLINE

$\oplus 0.010'' (0.25 \text{ MM}) \text{ (M) B (M)}$   
 4 PL

$\oplus 0.010'' (0.25 \text{ MM}) \text{ (M) T B (S) A (S)}$   
 8 PL

### SO-8

#### PACKAGE DIMENSIONS

DIM	MILLIMETERS		INCHES	
	MIN	MAX	MIN	MAX
A	4.80	5.00	0.189	0.196
B	3.80	4.00	0.150	0.157
C	1.35	1.75	0.054	0.068
D	0.35	0.49	0.014	0.019
F	0.40	1.250	0.016	0.049
G	1.27 BSC	1.27 BSC	0.05 BSC	0.05 BSC
J	0.18	0.25	0.007	0.009
K	0.10	0.25	0.004	0.008
P	5.80	6.20	0.229	0.244
R	0.25	0.50	0.010	0.019

#### NOTES

1. - T - = Seating Plane and Datum Surface.
2. Dimensions "A" and "B" are Datum.
3. Dimensions "A" and "B" do not include mold protrusion.
4. Maximum mold protrusion is 0.015" (0.380 mm) per side.
5. Dimensioning and tolerances per ANSI Y14.5M, 1982.
6. Dimensions are exclusive of mold flash and metal burrs.

#### TAPE & REEL/BULK ORDERING NOMENCLATURE

1. Surface mount product is taped and reeled in accordance with EIA-481.
2. Suffix-T7 = 7 Inch Reel - 1,000 pieces per 12mm tape.
3. Suffix-T13 = 13 Inch Reel - 2,500 pieces per 12mm tape.
4. No Suffix = Product Shipped in Tubes of 98 pcs per Tube.

Outline & Dimensions: Rev 1 - 11/01, 06009

### MOUNTING PAD

$0.050 + 0.005''$   
 $0.030 + 0.005''$   
 $0.160 + 0.005''$   
 $0.245'' \text{ M!}''$   
 $0.045 + 0.005''$